

スイベル可動範囲

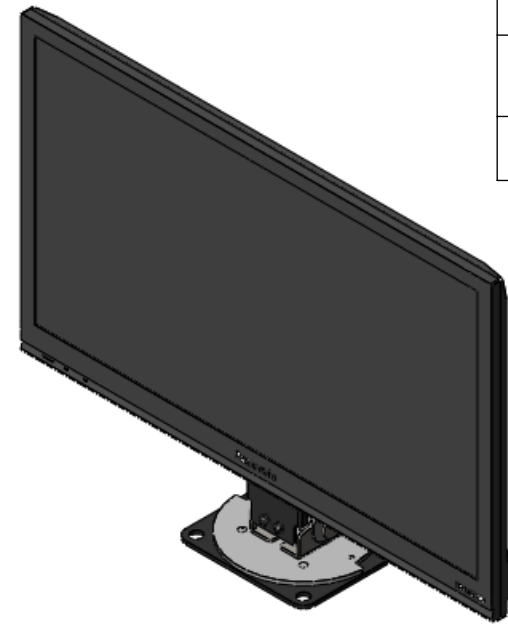

リビジョン				
バージョン	リビジョン	注記	日付	承認
	0	新規作成	15.06.24	

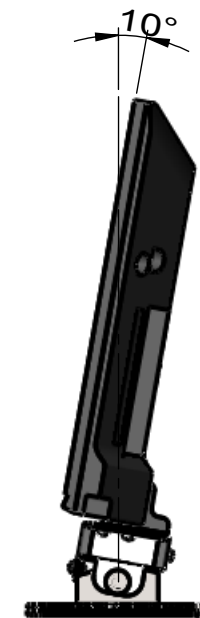
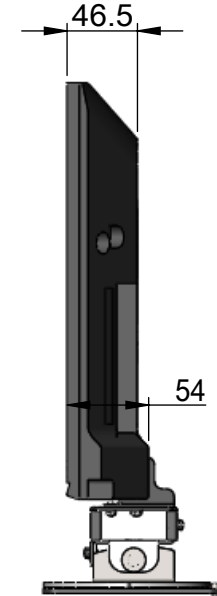
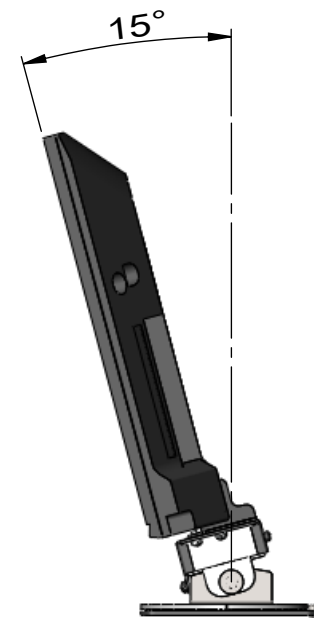
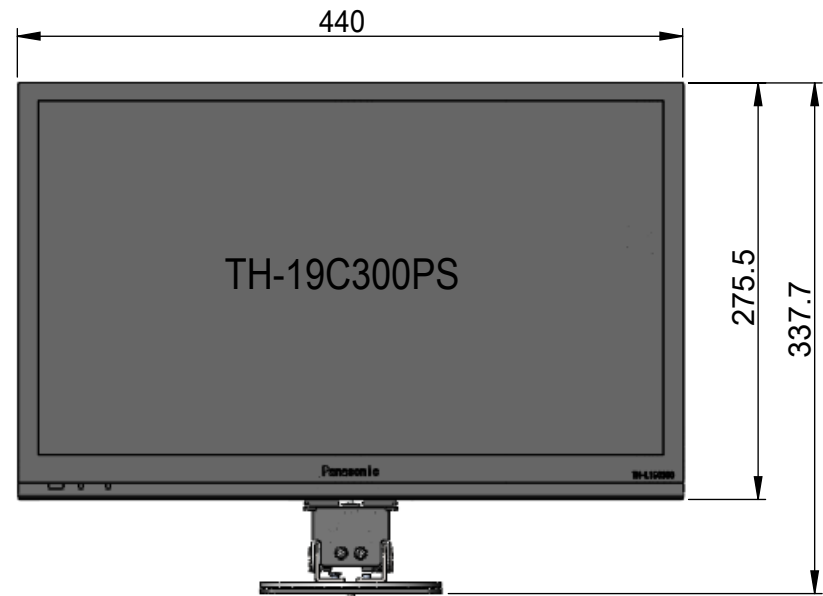

チルト可動範囲

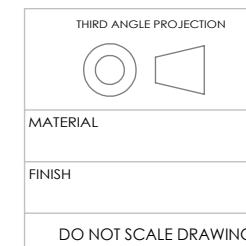
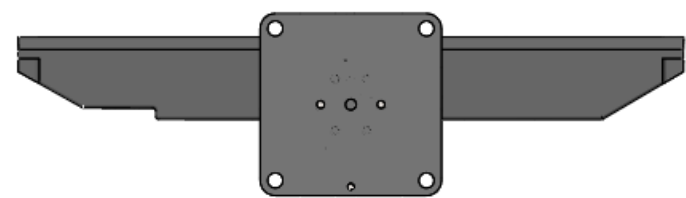

	NAME	DATE	ALPHATEC	
DRAWN	金子	15.06.24	TITLE:	
CHECKED			ST6A TH-19C300PS	
ENG APPR.			パナソニック	
MFG APPR.			SIZE	DWG. NO.
Q.A.			A3	ST6A-C300
COMMENTS:			REV	0
			SCALE: 1:5	SHEET 1 OF 1